

alpro®



*Commitment to
Excellence*

door handles



Commitment to Excellence

About Alpro

Alpro Architectural Hardware located in Poole, Dorset is an independent company and part of IEC Limited which is a family owned business founded in 1938 to supply quality mechanical components.

Alpro supplies a range of electro-mechanical access control products and a complete range of door hardware, including door handles, door closers, locks, flushbolts and cylinders specifically tailored to the needs of the OEM marketplace.

Alpro's UK based manufacturing

Alpro provides high quality products and customer service. To ensure this standard is achieved, significant investment has been made in the manufacturing facilities for Alpro handles. This enables Alpro to control material quality and cut lead times. Any defective materials are rejected on receipt and the finished Alpro handles are inspected immediately prior to despatch to ensure they are defect free.

The Impressionist standard stainless steel handles are made from grade 304 stainless steel. The Functional stainless steel handles are made from grade 316 stainless steel.

To guarantee customer satisfaction, Alpro's in-house Quality Management System run seamlessly from goods inwards inspection, across the manufacturing processes and ends with a final check for appearance and accuracy. Alpro handles and their fixing kits are then packed with care in robust cardboard containers for safe delivery.

Alpro's flexible facilities enable one-off bespoke designs to be produced in addition to the standard ranges. Customer's specialised needs are met using Alpro's in-house design capability. Changes can be made to appearance, materials, or design specification to meet changes in legislation or DDA compliance. High quality enhanced manufacturing ensures a speedy turn-round for special requirements meeting customer needs in full.

As an independent door hardware manufacturer and specialist Alpro provides a tailor made solution from the initial enquiry, through to final delivery. Reinforced by its specialised internal sales and support structure and its competitive pricing, Alpro stays at the forefront of the industry and continues to offer **First Choice** solutions.



pull handles

Quality

Quality Policy

Our success is built on our ability to provide our customers with quality products and standards of service that meet or exceed their expectations.

We shall continue to be successful by:

- **Ensuring** that quality is everybody's responsibility
- **Maintaining** an environment in which teamwork and involvement results in continuous improvements in the way we work
- **Improving** our skills by effective training and development
- **Working** on our Quality Management System which meets ISO 9001:2008
- **Providing** our customers with the right products at the right time from our specialist suppliers.

The Managing Director is ultimately responsible for the implementation of this policy with the assistance of our Quality Manager who controls the reviews, audits and works to ensure the unfailing maintenance of our quality standards.

Our policy is to provide an unrivalled service by getting it right first time and every time thereafter.



Environmental Factors

Alpro Hardware endeavors where ever possible to use environmentally friendly materials in the construction of its products and customer services. In line with its environmental policy Alpro handles are manufactured from both aluminium and stainless steel, both of which are 100% recyclable.

As the third most abundant element in the world (Bauxite) aluminium is both sustainable and recyclable. This means that as well as aesthetic advantages, savings can be made through superior performance (longevity and durability) of the material by reducing maintenance costs. Added to this is the non-toxicity of the material making for a safer working environment.

A recent report by **EUROFER (January 1999)** **"Manufacturer Processing and Use of Stainless Steel: A Review of Health Effects"** concluded that:

Stainless steel does not cause adverse effects on health and so does not need to be classified as hazardous to health.

There is no data available to suggest manufacture of stainless steel affects the health of the workers.

The grinding and cutting of stainless steel do not appear to carry any adverse health effects

In addition stainless steel allows the minimization of waste, with all discarded parts, collected, recycled and returned to the furnace for re-use.

In addition to the above economic and environmental benefits, Alpro handles also conform to all relevant legislation regarding the Disability and Discrimination Act 2004.

pull handles

Finishes / RAL Colours

Finishes

- Satin Anodised (SAA)
- Satin Stainless Steel (SSS)
- Polished Stainless Steel (PSS)
- Powder Coated (PC)
- Painted Nylon Coat (NC)

Handles are available in both painted nylon and powder coating.

However since the costs of both nylon and powder coating are identical we strongly recommend the use of painted nylon. The painted nylon coat gives a superior durability and conforms to the Disability and Discrimination Act 2004 (Part 3 Provision of Services) with regard to the improvement of thermal conductivity. Painted nylon is applied to the base material of the handle (70/100 microns thick) and is available in five ex-stock colours, as show in the colour chart below.

Additional colours are available with a 10 working day turn-around and some colours also carry an additional price surcharge.

Additional finishes are available. If the finish required is not shown, please contact our sales office on 01202 676262 for further help.

If the finish you require is not shown please contact us

Ex Stock Colours

Black
RAL9005

White Aluminium
RAL9006

White
RAL9010

Agate Grey
RAL7038

Ultra Marine Blue
RAL5002

This colour chart is for guidance only. We recommend you check your final colour choice



pull handles

Handle Range

Impressionist Range

The Impressionist range of door handles are bold and modern in appearance, as well as being practical in everyday use. Manufactured in 32mm diameter, the look and feel is strong and robust, yet aesthetically pleasing to the eye. Available from stock in aluminium, stainless steel, polished stainless steel and a numerous range of painted nylon coated colours in the 02 and 05 Series; this range truly does make "an impression".

01 Series Straight pull handles

02 Series Offset cranked pull handles

03 Series Circular pull handle

05 Series Spigot mounted circular pull handle

Impressionist handles are designed for aluminium, timber and glass door applications.

Functional Range

97 Series

The 97 series of pull handles are manufactured in 41mm diameter for Satin Anodised (SAA) and Painted Nylon Coat (NC). Finishes for 38 diameter are Stainless Steel (SSS) and Polished Stainless Steel (PSS). They come in a range of sizes up to 3000mm.

All sizes are available in either straight or offset versions and are suitable for bolt-thru (single side fixing) or back to back fixing.

Note: For handles over 2400mm long we advise using a centre fixing bracket.

98 Series

The 98 series of pull handles are manufactured in 25, 32 and 38mm diameters. They come in a range of sizes. (Please contact our Sales Office on 01202 676262 for further help)

All versions are suitable for bolt-thru (single side fixing) or back to back fixing.

Also available with straight or offset pillar (327 straight / 328 offset)

99 Series Pad Handle

The 99 series is an attractive pad handle.

Functional handles are designed for aluminium, timber or glass door applications.



pull handles

Impressionist 01 series

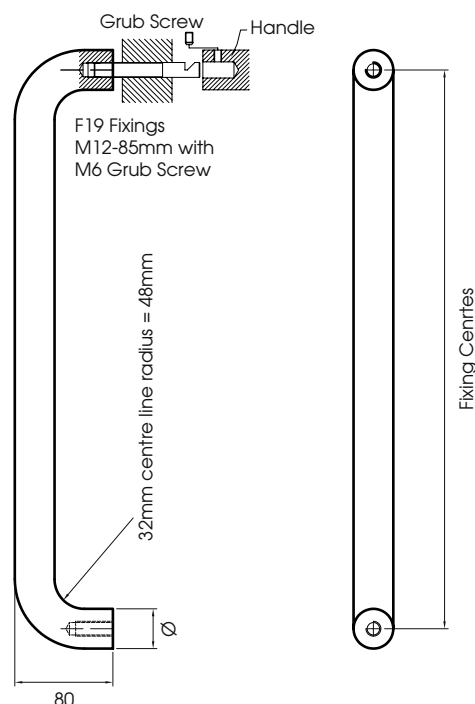
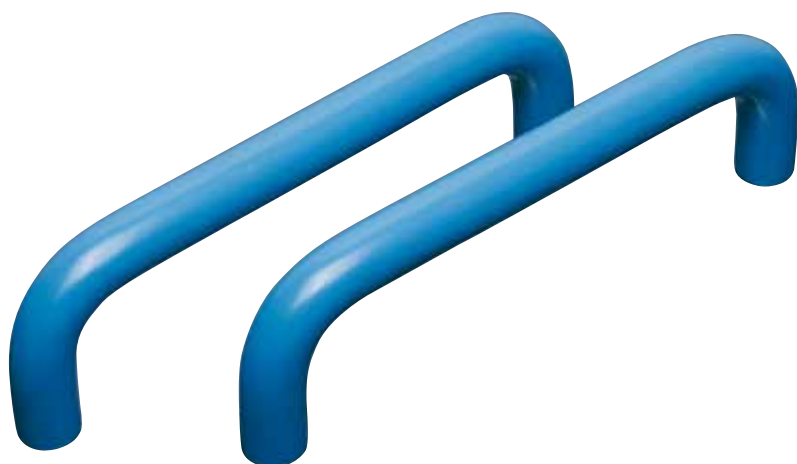

Series	Diameter Ø	Centres	Projection	Throw	Overrun	Finishes Available	Code
Imp 01	32	300 / 400 / 600	80	N/A	N/A	Satin Anodised	SAA
						Satin Stainless	SSS
						Polished Stainless	PSS
						Powder Coated	PC
						Painted Nylon Coat	NC

All dimensions shown are in millimetres

Ordering Guide - please specify the following details:

Series	Ø	Size	Fixing Kit	Finish	Door Type
Imp 01	32	300	F19	SSS	Aluminium

Notes

Handles are supplied with bolt-thru or back to back fixing as standard.

Back to back kits come with F19, F20 and F21 fixings.

Bolt-thru kits come with F26 and F34 fixings.

Fixing kit information can be found at the back of this catalogue.

Stainless steel and polished stainless steel handles are manufactured from 304 grade stainless steel.

Powder coated and painted nylon coat handle colours are not ex-stock colours. Additional lead times should be allowed for these items and may be subject to a paint surcharge.

Colour options

For powder coated and painted nylon coat handles please contact our Sales Team on 01202 676262 for price and availability.

pull handles

Impressionist 02 series

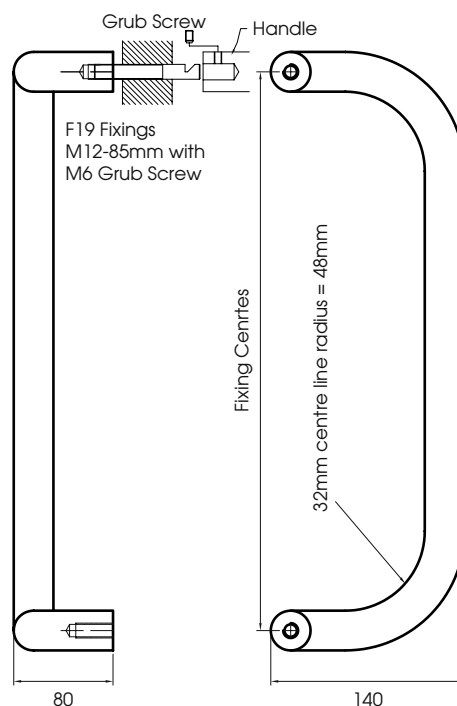
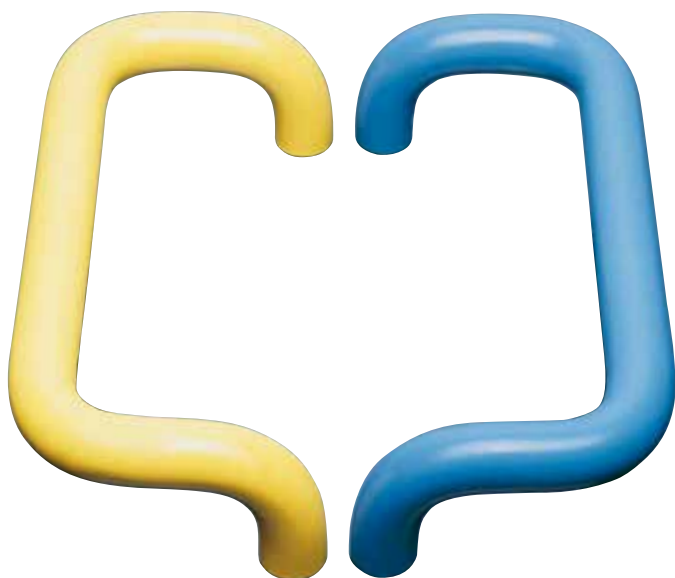

Series	Diameter Ø	Centres	Projection	Throw	Overrun	Finishes Available	Code
Imp 02	32	250 / 300 / 400 / 600	80	140	N/A	Satin Anodised	SAA
						Satin Stainless	SSS
						Polished Stainless	PSS
						Powder Coated	PC
						Painted Nylon Coat	NC

All dimensions shown are in millimetres

Ordering Guide - please specify the following details:

Series	Ø	Size	Fixing Kit	Finish	Door Type
Imp 02	32	300	F19	SSS	Aluminium

Notes

Handles are supplied with bolt-thru or back to back fixing as standard.

Back to back kits come with F19, F20 and F21 fixings.

Bolt-thru kits come with F26 and F34 fixings.

Fixing kit information can be found at the back of this catalogue.

Stainless steel handles are manufactured from 304 grade stainless steel.

The following painted nylon coat colours are available ex stock:

Black	(RAL9005)
White	(RAL9010)
Ultra Marine Blue	(RAL5002)
White Aluminium	(RAL9006)
Agate Grey	(RAL7038)

Additional colours are available at extra cost with a 10 working day lead time.

If the finish you require is not shown please contact us.

pull handles

Impressionist 03 Series

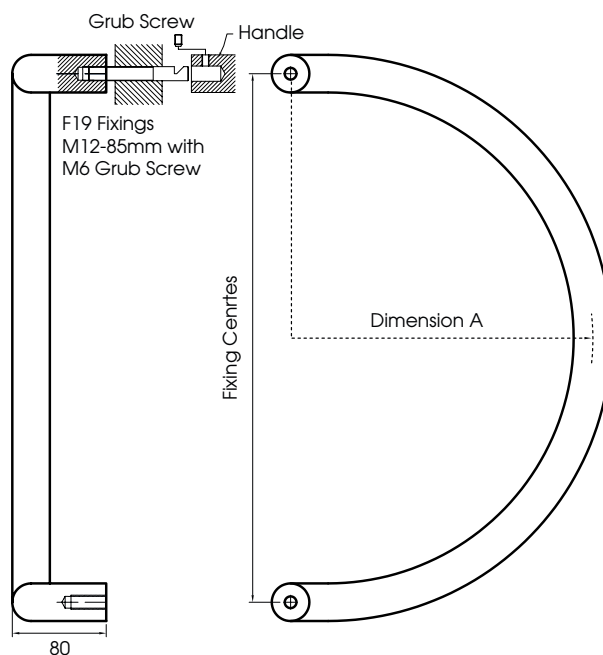
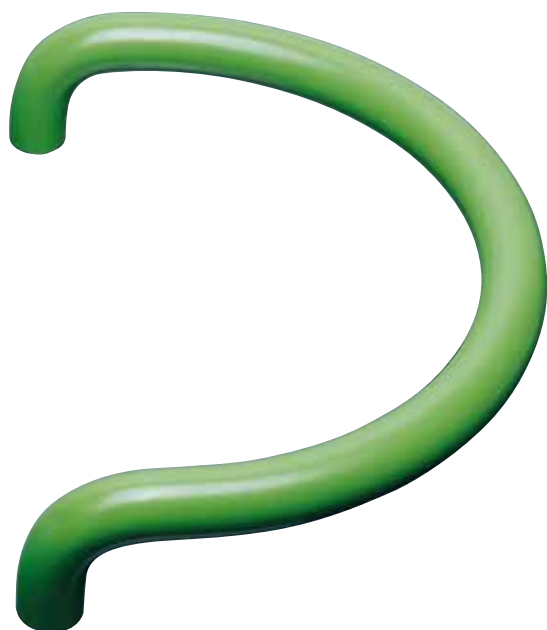

Dimension A
 250mm C/C = 165mm curve
 350mm C/C = 215mm curve

All dimensions shown are in millimetres

Series	Diameter Ø	Centres	Projection	Throw	Overrun	Finishes Available	Code
Imp 03	32	250	80	N/A	N/A	Satin Anodised	SAA
Imp 03	38	350	80	N/A	N/A	Satin Stainless	SSS
						Polished Stainless	PSS
						Powder Coated	PC
						Painted Nylon Coat	NC

All dimensions shown are in millimetres

Ordering Guide - please specify the following details:

Series	Ø	Size	Fixing Kit	Finish	Door Type
Imp 03	32	250	F19	SSS	Aluminium

Notes

Handles are supplied with bolt-thru or back to back fixing as standard.

Back to back kits come with F19, F20 and F21 fixings.

Bolt-thru kits come with F26 and F34 fixings.

Fixing kit information can be found at the back of this catalogue.

Stainless steel and polished stainless steel handles are manufactured from 304 grade stainless steel.

Powder coated and painted nylon coat handle colours are not ex-stock colours. Additional lead times should be allowed for these items and may be subject to a paint surcharge.

Colour options

For powder coated and painted nylon coat handles please contact our Sales Team on 01202 676262 for price and availability.

pull handles

Impressionist 05 series

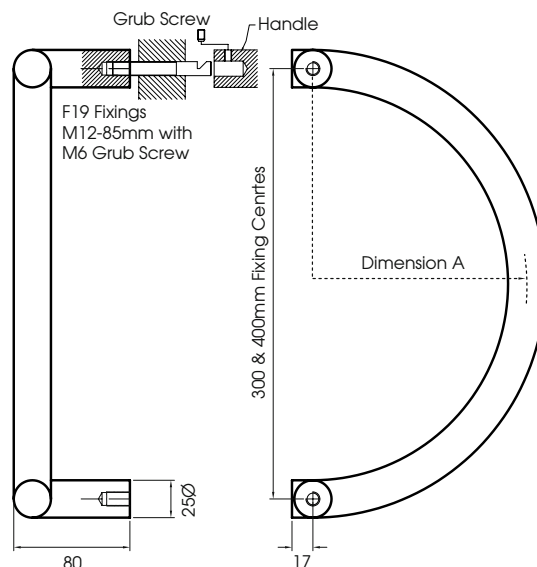

Dimension A
400mm C/C = 183mm curve
300mm C/C = 132mm curve

All dimensions shown are in millimetres

Series	Diameter Ø	Centres	Projection	Throw	Overrun	Finishes Available	Code
Imp 05	32	300 / 400	80	N/A	5	Satin Anodised	SAA
						Satin Stainless	SSS
						Polished Stainless	PSS
						Powder Coated	PC
						Painted Nylon Coat	NC

All dimensions shown are in millimetres

Ordering Guide - please specify the following details:

Series	Ø	Size	Fixing Kit	Finish	Door Type
Imp 05	32	300	F19	SSS	Aluminium

Notes

Handles are supplied with bolt-thru or back to back fixing as standard.

Back to back kits come with F19, F20 and F21 fixings.

Bolt-thru kits come with F26 and F34 fixings.

Fixing kit information can be found at the back of this catalogue.

Stainless steel and polished stainless steel handles are manufactured from 304 grade stainless steel.

The following painted nylon coat colours are available ex stock:

Black (RAL9005)
White (RAL9010)
Ultra Marine Blue (RAL5002)
White Aluminium (RAL9006)
Agate Grey (RAL7038)

Additional colours are available at extra cost with a 10 working day lead time.

If the finish you require is not shown please contact us.

pull handles

Functional 97 Series

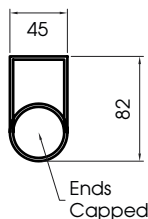

**97-325
Straight pull
handle**

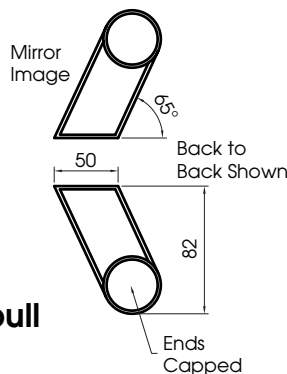

**97-326
Offset pull
handle**

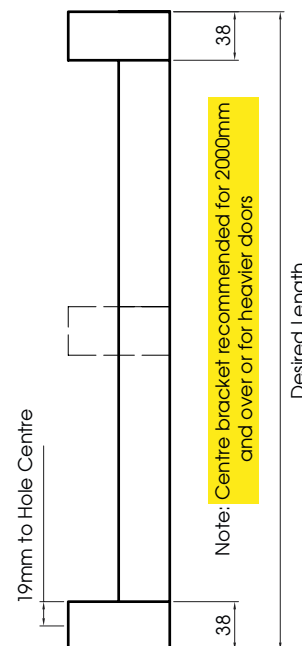

Available in all finishes shown below

Series	Diameter Ø	Centres	Projection	Throw	Overrun	Finishes Available	Code
97	41	Up to 3000	82	N/A	N/A	Satin Anodised	SAA
97	38	Up to 3000	82	N/A	N/A	Satin Stainless	SSS
97	38	Up to 3000	82	N/A	N/A	Polished Stainless	PSS
97	41	Up to 3000	82	N/A	N/A	Powder Coated	PC
97	41	Up to 3000	82	N/A	N/A	Painted Nylon Coat	NC

All dimensions shown are in millimetres

Note the 97-326 - has a 39mm throw. Handles can be supplied assembled or unassembled - please specify.

Ordering Guide - please specify the following details:

Series	Size	Fixing Kit	Finish	Door Type
97-325 or 97-326	305	F27	SSS	Aluminium

Notes

Handles are supplied with bolt-thru or back to back fixing as standard. F27 fixing kit is provided as standard. (Please contact the office if an alternative is required).

Stainless steel and polished stainless steel handles manufactured from 316 grade stainless steel.

Powder coated and painted nylon coat handle colours are not ex-stock colours. Additional lead times should be allowed for these items and may be subject to a paint surcharge.

Centre bracket recommended for applications of 2000mm and over.

Please specify at time of order if the length given is overall handle length or the cross centres of the fixing holes. **THIS IS IMPORTANT.**

Colour options

For powder coated and painted nylon coat handles please contact our Sales Team on 01202 676262 for price and availability.

Please check with the office for current lead times.

pull handles

Functional 98 series

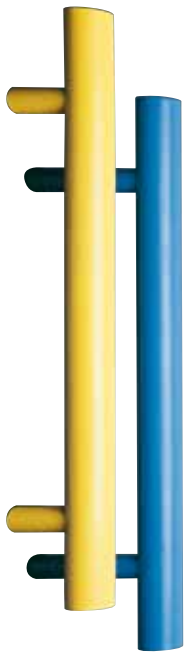

Offset Cranked Handle

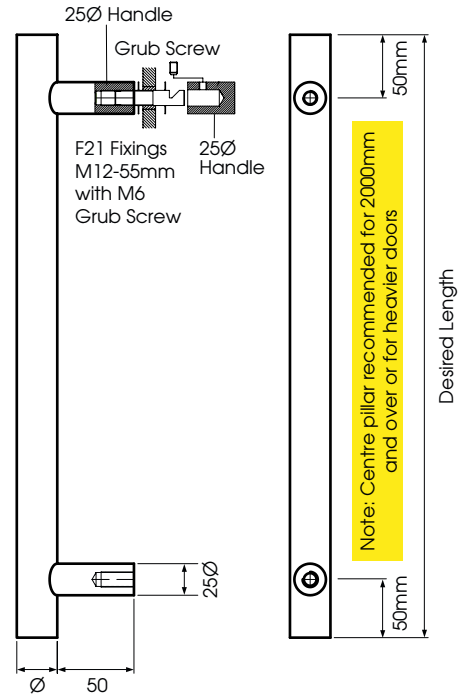
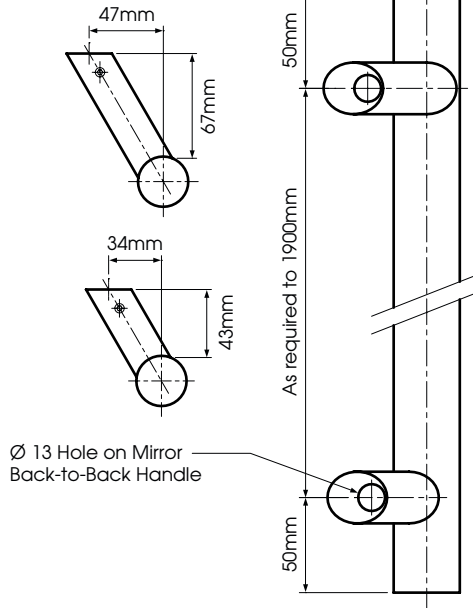

See above for offset projection, below is for straight pillars only.

Available in all finishes shown below

Series	Diameter Ø	Centres	Projection	Throw	Overrun	Finishes Available	Code
98	25, 32 & 38	Please contact Sales Office	50	N/A	50	Satin Anodised	SAA
98	25, 32 & 38		50	N/A	50	Satin Stainless	SSS
98	25, 32 & 38		50	N/A	50	Polished Stainless	PSS
98	25, 32 & 38		50	N/A	50	Powder Coated	PC
98	25, 32 & 38		50	N/A	50	Painted Nylon Coat	NC

All dimensions shown are in millimetres

Ordering Guide - please specify the following details:

Series	Ø	Size	Fixing Kit	Finish	Door Type
98-327 or 97-328	32	400	F21	SSS	Aluminium

Notes

98-327 Straight pull handle

98-328 Offset pull handle

Back to back handles supplied with F19 fixing kit as standard. (Please contact the office if an alternative is required).

Handles are supplied with bolt-thru or back to back fixing as standard.

Fixing kit information can be found at the back of this catalogue.

Stainless steel and polished stainless steel handles are manufactured from 316 grade stainless steel.

Powder coated and painted nylon coat handle colours are not ex-stock colours. Additional lead times should be allowed for these items and may be subject to a paint surcharge.

Colour options

For powder coated and painted nylon coat handles please contact our Sales Team on 01202 676262 for price and availability.

Please check with the office for current lead times.

pull handles

Functional 99 series - Pad Handles

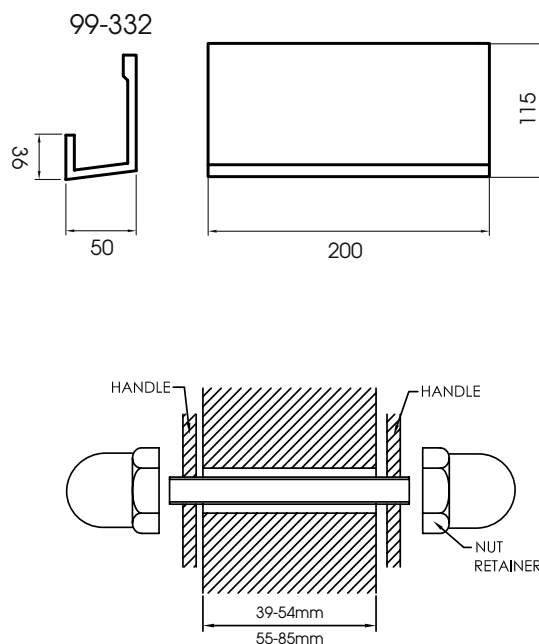
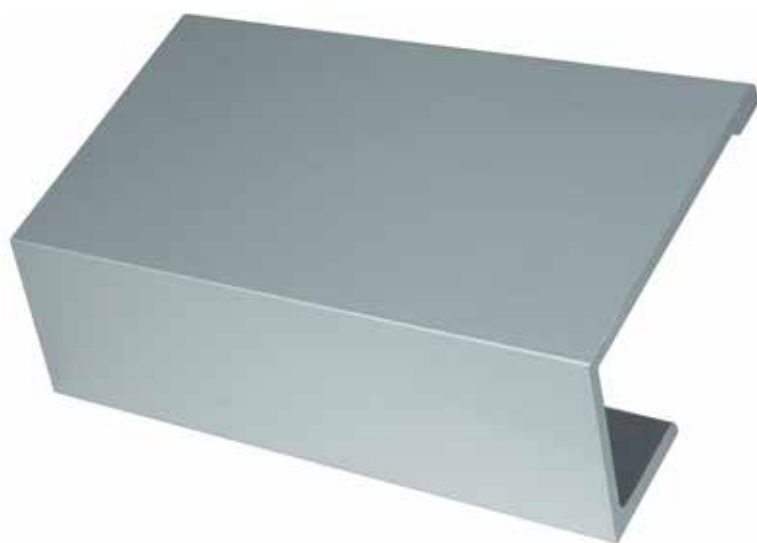

All dimensions shown are in millimetres

Series	Diameter Ø	Centres	Projection	Throw	Overrun	Finishes Available	Code
99-332	N/A	N/A	50	N/A	N/A	Satin Anodised	SAA
						Powder Coated	PC
						Mill	MILL
						Painted Nylon Coat	NC

Ordering Guide - please specify the following details:

Series	Ø	Size	Fixing Kit	Finish	Door Type
99-332	N/A	N/A	N/A	SAA	Aluminium

Notes

Fixings not provided.

Handles are sold singular.

Powder coated handles and painted nylon coat handle colours are not ex-stock. Additional lead times should be allowed for these items and may be subject to a paint surcharge.

Fixing kits: (1 per handle or 1 per back to back pairs)

99.PADFIXKIT1 - Doors 39 - 54mm thick

99.PADFIXKIT2 - Doors 55 - 85mm thick

Colour options

For powder coated and painted nylon coat handles please contact our Sales Team on 01202 676262 for price and availability.

pull handles

Fixing information

All Alpro handles are supplied with their own dedicated fixing packs, which suit all the possible door materials available. Full fixing and maintenance instructions are included in the handle kits, to ensure the correct methodology is employed when fixing the handles. In the event of the fixing kits being mislaid or broken, replacement kits are available by contacting the Alpro sales office on 01202 676262 and specifying the necessary requirements.

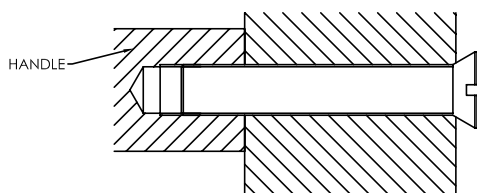

F17

39-54mm thick doors

For 32mm Ø Impressionist handles

For 25, 32 & 38mm Ø Functional 98 series handles

M12-70mm countersunk

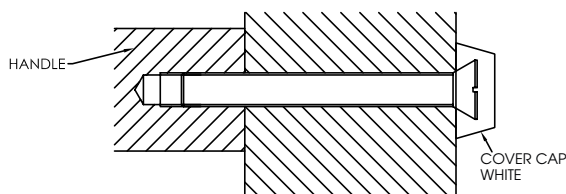

F18

55-85mm thick doors

or 32mm Ø Impressionist handles

For 25, 32 & 38mm Ø Functional 98 series handles

M12-90mm countersunk

For black cover cap - F18BLACK

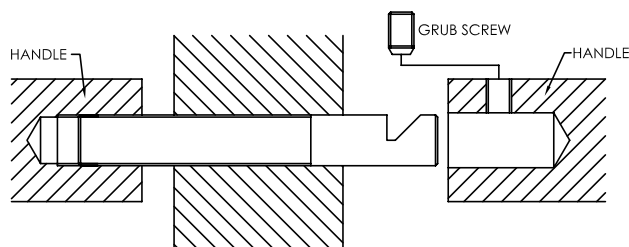

F19

39-54mm thick doors

or 32mm Ø Impressionist handles

For 25, 32 & 38mm Ø Functional 98 series handles

M12-90mm with M6 grub screw

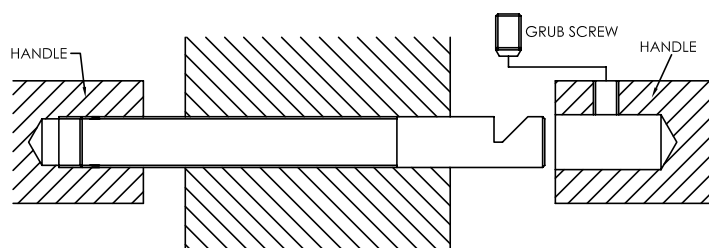

F20

55-85mm thick doors

or 32mm Ø Impressionist handles

For 25, 32 & 38mm Ø Functional 98 series handles

M12-120mm with M6 grub screw

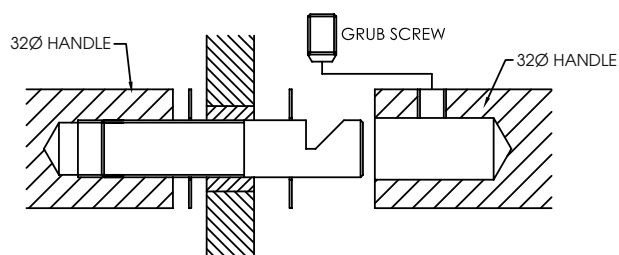

F21

Glass doors

For 32mm Ø Impressionist handles

For 25, 32 & 38mm Ø Functional 98 series handles

M12-55.5mm with M6 grub screw

pull handles

Fixing information

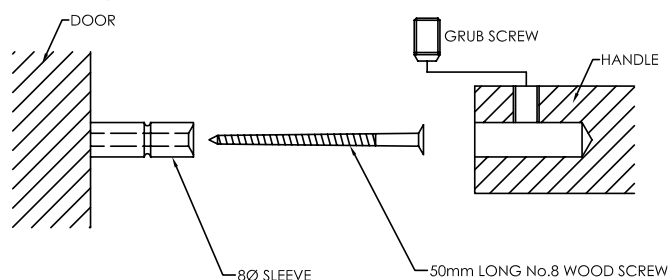

F22 Secret fixing

For fixing to a wooden door 25mm deep
For 32mm Ø Impressionist handles
NB - Use these fixings for timber doors only
(This fixing is not recommended on Aluminium doors)

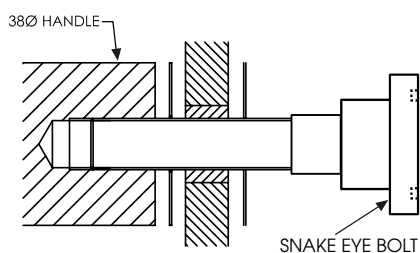

F25.2KIT

Glass doors (Single side)
For Impressionist handles
For Functional 98 series - single side glass fixing
2 x 90mm XM12 bolts
Snake eye fixing 25mm head x 5mm thick

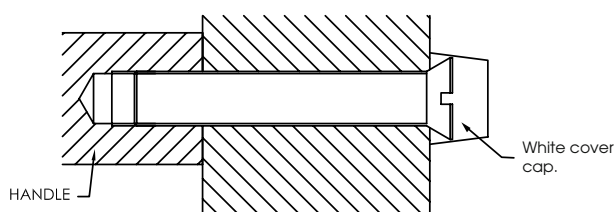

F26

39-54mm thick doors
For 32mm Ø Impressionist handles
For 25, 32 & 38mm Ø Functional 98 series handles
M12-70mm countersunk with dome cap
NB - Cover cap is available in black on request

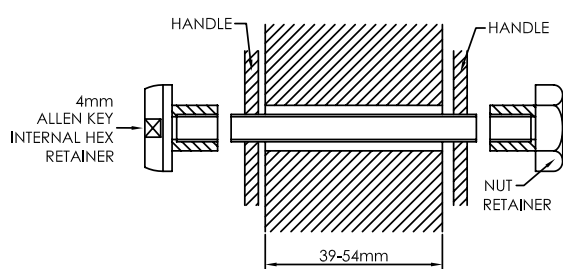

F27

10mm Ø clearance hole required
For Functional 97 Series handles
*Suitable for back to back pairs and single handles

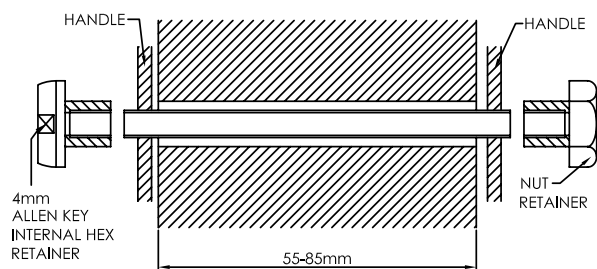

F28

10mm Ø clearance hole required
For Functional 97 Series handles
*Suitable for back to back pairs and single handles

pull handles

Fixing information

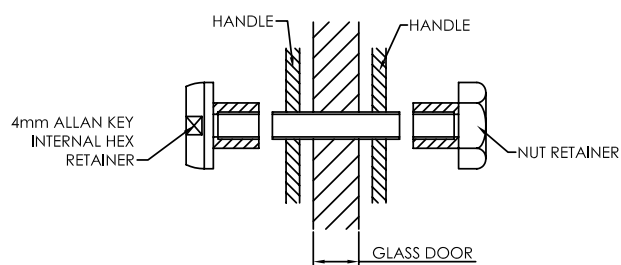

F29

Minimum 11.5mm Ø clearance hole required, maximum 12mm

For Functional 97 Series handles

*Suitable for back to back pairs and single handles

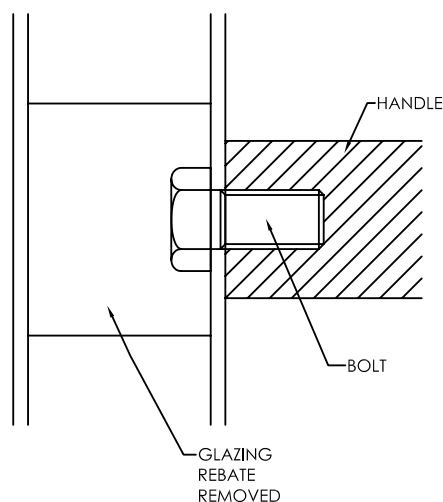

F34

M12 fixings

For 32mm Ø Impressionist handles

For 25, 32 & 38mm Ø Functional 98 series handles

M12 x 25mm long hexagon headed bolt grade 8.8.

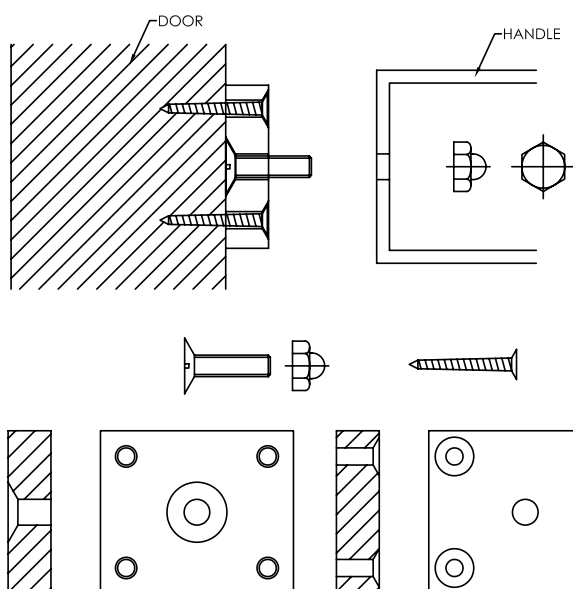

F38

For Functional 97 Series handles only

M6 x 20mm long countersunk bolt and 4 off No. 8 x 25 long wood screws

HOLE SIZES FOR FIXING THROUGH:

For M12 fixing - Wood & Aluminium = 13mm Ø

For M12 fixing - Glass = 18mm Ø

pull handles

Disabilities Discrimination Act 2004

DDA Part 3 Provision of Services December 1996 - October 2004

The building regulations control how you carry out construction and modifications to your property.

The legislation that governs the accessibility of buildings, with regards to disabled people has been significantly revised.

The Disability and Discrimination Act Part 3, Provision of Services, became law on the 1st October 2004. From this moment in time the requirements for service providers to make "Reasonable adjustments" to their buildings to ensure disabled people can access services has changed. You need therefore to be aware of how this legislation will affect you.

The Legislation

The Discrimination Act 1995, as amended by the Special Education Needs and Disability Act 2001 (SENDA). Building Regulations Part M revised to meet new standards (May 2004). These standards are comprehensively summarised in BS8300 (2001), Design of Buildings and their approaches to meet the needs of disabled people.

This information has been designed to help you, to continue to order and use Alpro products, with the confidence that the requirements of the new legislation are being met.

Q What are the new regulations designed to achieve?

A In a word, Equality. The new legislation is about the civil rights of disabled people receiving the same services and provisions that are available for the non disabled. It is about removing barriers, in areas such as attitude, environment and organisation.

Q How will this affect ingress and egress to and from buildings?

A Disabled people need to be able to get inside buildings, move around freely once inside and exit in a safe way. This may mean wider doorways, signage that can be seen from a seated or standing position, colour contrasts for door furniture, auto door operators, audio information, adequate way finding and level access or lift access.

Q How will this affect door design?

A The requirements for the design of doors will vary according to location and context. These requirements are comprehensively covered by BS8300 and Document M. Contained within these publications are door closer strengths and colour contrast information with regard to door furniture. Although it should be noted that both of these areas are the subject of ongoing debate, with the Office of the Deputy Prime Minister. Once these areas have been agreed and resolved it may be that BS8300 is rewritten, incorporating new or additional requirements.

Q Do I have to comply with the new legislation?

A Yes, but the major issue here is what is seen as "Reasonable Adjustment" on the part of the service provider. The context of the building has to be taken into account and whether there are other ways of achieving compliance. For example is there an additional entrance into the building, other than the primary front entrance? Perhaps access to the building can be achieved through a side entrance that is already wide enough to accept wheelchairs. Advice needs to be sought from the Building Control officer. Since December 1996 it has been unlawful to treat disabled people less favourably because of their disability. Since October 2004 service providers have a duty to make "Reasonable Adjustments".

Q What are the requirements for door furniture?

A The regulations at present state that there should be a colour contrast between the door finish and the door furniture, and that the door furniture is not cold to the touch. Recent research has shown that a matt finish is better suited for the visually impaired. Currently discussions are ongoing with the Office of the Deputy Prime Minister to clarify the exact requirements. Additional information can be obtained from Alpro.

Q How will the legislation be enforced?

A Enforcement of Part 3 of the DDA legislation will be by individuals taking service providers to court to sue if they feel they have been treated unfairly. The court will then look at the "Reasonable Adjustments" made. Discrimination will be deemed to have taken place if the service provider cannot show that the treatment in question is justified. The court will judge on "What is reasonable in all the circumstances of the case". Part M requires "Reasonable Provision" to make buildings accessible, compliance with Part M can be used to establish "Reasonable Adjustment" under the DDA legislation.

Q Who has to comply with the act?

A Anybody who provides a service. The provision of services includes the provision of any goods or facilities. It is irrelevant whether the service is provided without payment.

Additional Information

- Local planning authority.
- Building Regulations Part M 2004 Edition "Access to and use of buildings".
- BS8300 (2001) "Design of buildings and their approaches to meet the needs of disabled people".
- BS7036 Code of Practice for Safety at Powered Doors for pedestrian use.

pull handles

Care & Maintenance

Care & Maintenance of Alpro Stainless Steel Handles

Introduction

Stainless steels are selected in applications where their inherent corrosion resistance, strength and aesthetic appeal are required. However, dependent on the service conditions, stainless steels will stain and discolour due to surface deposits and so cannot be assumed to be completely maintenance free. In order to achieve maximum corrosion resistance and aesthetic appeal, the surface of the stainless steel must be kept clean. Provided the grade of stainless steel and the surface finish are correctly selected, and cleaning schedules carried out on a regular basis, good performance and long service life will result.

Factors Affecting Maintenance

Surface contamination and the formation of deposits must be prevented. These deposits may be minute particles of iron or rust from other sources used on the building of new premises and not removed until after the stainless steel items have been fixed. Industrial and even naturally occurring atmospheric conditions can produce deposits, which can be equally corrosive, e.g. salt deposits from marine conditions.

Working environments can also provide aggressive conditions such as heat and humidity, in swimming pool buildings. These conditions can result in surface discoloration of stainless steels and so maintenance on a more frequent basis may be required.

Modern processes use many cleaners, sterilizers and bleaches for hygienic purposes. Proprietary solutions, when used in accordance with makers' instructions, should be safe but if used incorrectly (e.g. warm or concentrated), may cause discolouration or corrosion on stainless steels. Strong acid solutions are sometimes used to clean masonry and tiling of buildings. These acids should never be used where contact with metals, including stainless steel is possible, but if this happens, the acid solution must be removed immediately, followed by dilution and rinsing with clean water.

Maintenance Programme

With care taken during fabrication and installation, cleaning before "hand-over" should not present any problems. More attention may be required if the installation period has been prolonged or hand-over delayed. Where surface contamination is suspected, immediate cleaning after site fixing should avoid problems later. Food handling, pharmaceutical, aerospace and certain nuclear applications required extremely high levels of cleanliness applicable to each industry.

The frequency of cleaning is dependent on the application; a simple rule is; "Clean the metal when it is dirty in order to restore its original appearance". This may vary from once to four times a year for external applications, but may be daily for items in "hygienic" applications. Recommendations on cleaning frequencies in architectural applications are shown in Table 2 page 18.

Cleaning Methods

Stainless steel is easy to clean. Washing with soap or mild detergent and warm water followed by a clear water rinse is usually quite adequate for domestic and architectural equipment. Where stainless steel has become extremely dirty with signs of surface discolouration (perhaps following periods of neglect, or misuse) alternative methods of cleaning can be used, as outlined in the Table 1 page 18.

Acknowledgements

Stainless Steel Advisory Service 12th March 2001.

References

Assessment of Cleaners and Polishes for use on Stainless Steel
British Steel Swinden technology Centre-Confidential Report SL/SSE/RGC/S1147/1/97/R
PF Freeman.

Architects Guide to Stainless Steel
Steel Construction Institute-SCI-P-179
N Baddoo, R Burgan, R Ogden.

PLEASE NOTE: before commencing any tasks ensure that you have received the appropriate health and safety literature from the supplier and that you fully understand it. If in any doubt please seek advice.

The advice provided is given in good faith but without responsibility.

Care & Maintenance of Alpro Coated and Anodised Handles

For the maintenance of coated handles, a mild solution of warm water and appropriate detergent is suggested. All surfaces of the handle should be cleaned, using a soft cloth or brush and dried thoroughly. Again a frequency of every three to six months is suggested.

Satin anodised door furniture, should be wiped over with a damp cloth and thoroughly dried, a wipe over with wax polish is then suggested to ensure ongoing aesthetics. Never use metal cleaning agents on aluminium anodised furniture.

pull handles

Care & Maintenance

Table 1 - Summary of Cleaning Methods for Stainless Steel

Requirement	Suggested Method	Comments
Routine cleaning of light soiling	Soap, detergent or dilute (1%) ammonia solution in warm clean water. Apply with a clean sponge, soft cloth or soft-fibre brush then rinse in clean water and dry.	Satisfactory on most surfaces.
Fingerprints	Detergent and warm water, alternatively, hydrocarbon solvent.	Proprietary spray-applied polishes available to clean and minimise remarking.
Oil and grease marks	Hydrocarbon solvents (methylated spirit, isopropyl alcohol or acetone).	Alkaline formulations are also available with surfactant additions e.g. "D7" Polish.
Stubborn spots, stains and light discolouration. Watermarking. Light rust staining	Mild, non-scratching creams and polishes. Apply with soft cloth or soft sponge and rinse off residues with clean water and dry.	Avoid cleaning pastes with abrasive additions. Suitable cream cleansers are available with soft calcium carbonate additions, e.g. "Cif", or with the addition of citric acid, e.g. "Shiny Sinks". Do not use chloride solutions.
Burnt on food or carbon deposits	Pre-soak in hot water with detergent or ammonia solution. Remove deposits with nylon brush and fine scouring powder if necessary. Repeat if necessary and finish with "routine cleaning".	Abrasive scouring powder can leave scratch marks on polished surfaces.
Tannin (tea) stains and oily deposits in coffee urns	Tannin stains - soak a hot solution of washing soda i.e. sodium carbonate Coffee deposits - soak in a hot solution of baking soda (sodium bicarbonate).	These solutions can also applied with a soft cloth or sponge. Rinse with clean water. Satisfactory on most surfaces.
Adherent hard water scales and mortar/cement splashes	10-15 volume % solution of phosphoric acid. Use warm neutralise with dilute ammonia solution, rinse with clean water and dry. Alternatively soak in a 25% vinegar solution and use a nylon brush to remove deposits.	Proprietary formulations available with surfactant additions Take special care when using hydrochloric acid based mortar removers.
Heating or heavy discolouration	a) Non-scratching cream or polish e.g. Solvol Auto Chrome Metal Polish. b) Nylon-type pad, e.g. 'Scotchbrite'.	Creams are suitable for most finishes, but only use "Solvol" on bright polished surfaces. Some slight scratching can be left. Use on brushed and polished finishes along the grain.
Badly neglected surfaces with accumulated grime deposits	A fine, abrasive paste as used for car body refinishing, e.g. 'T-Cut' rinsed clean to remove all paste material & dried.	May brighten dull finishes. To avoid a patchy appearance, the whole surface may need to be treated.
Paint, graffiti	Proprietary alkaline or solvent paint strippers, depending upon paint type. Use soft nylon or bristle brush on patterned surfaces.	Apply as directed by manufacturer.

Table 2 - Cleaning Frequency in Architectural Applications for Common Stainless Steel Grades Specified (See reference 2)

Location	1.4016 (430)	1.4301 (304)	1.4401 (316)
Internal	As required to maintain appearance or design		
Suburban or rural	6-12 month intervals (as appropriate to location and design)		
Industrial or urban	Not recommended	3-6 months	6-12 months
Coastal or marine	Not Recommended	Not recommended	6-12 months

The above table is for guidance only and handles should be cleaned as required bearing in mind the location. Frequency of cleaning may depend on external factors such as window cleaning solutions used in the handle vicinity.

other products

Door Hardware

Alpro offer a complete range of aluminium door hardware offering excellent levels of security and quality.

The range includes:

- Europrofile Deadlocks
- Round Mortice Cylinder Deadlocks
- Europrofile Deadlatches
- Round Mortice Cylinder Deadlatches
- Lever & Paddle Handles
- Lock Accessories
- Flush Bolts
- Armoured Strikes
- Digital Locks
- Transom Door Closers
- Magnets



Access Control

Alpro also offer a comprehensive range of high quality, high security access control products to suit even the most demanding of situations.

The range includes:

- Electric Strikes
- Deadlocking Bolts
- Mini Solenoid Bolts
- Infrared Proximity Switches
- Compact Shearlocks
- Cabinet Locks
- Vortex Magnets
- Waterproof Keypads
- Waterproof Exit Switches
- Interlock Controllers
- Power Supply Units



Our difference...



We are a family owned company founded in 1938 to supply quality mechanical components. Today we serve a broad band of industry with a wide range of quality products.

These are manufactured by companies of international repute who are each specialists in their own field.

We are approved to BS EN ISO 9001:2008.

We aim to provide the best in both products and service

- Experienced informative staff give fast, effective and friendly service.
- Technical support nationwide.
- Competitive and cost effective solutions.
- CAD design facility.
- Large stocks - same day despatch - Kanban and JIT deliveries.
- Modern technology combined with people.
- Listen, communicate - no surprises!
- Think long term - everlasting customers.



alpro®... the team that cares

Integrity • Expertise • Commitment

IEC Limited, Harwell Road, Nuffield Estate, Poole, Dorset BH17 0BD Great Britain

Registered in England 1925537

04/2018



T 01202 676262
F 01202 680101
E info@alpro.co.uk
W www.alpro.co.uk